

UR-UD UH-US	A 903														
	Tutti / All Alle / Tous		Motore / Motor / Motoren / Moteur M_						Motore / Motor / Motoren / Moteur M_FD						
	Y	Y ₁	J ₃	P ₂	Z ₁	Z ₂	Z ₃		J ₂	J ₃	P ₁	Z ₁	Z ₂	Z ₃	
A 903_S3 M3SA	195	398	530	876	98	98	135	435	160	576	971	165	110	155	440
A 903_S3 M3LA	195	398	530	907	98	98	135	437	160	576	999	165	110	155	442
A 903_S3 M3LB	195	398	530	907	98	98	135	441	160	576	999	165	110	155	446
A 903_S3 M3LC	195	398	530	907	98	98	135	444	160	576	999	165	110	155	450
A 903_S4 M4SA	258	429	548	975	118	118	193	455	204	632	1088	118	118	193	465
A 903_S4 M4SB	258	429	548	975	118	118	193	461	204	632	1088	118	118	193	471
A 903_S4 M4LA	258	429	548	1013	118	118	193	462	204	632	1125	118	118	193	472
A 903_S4 M4LB	258	429	548	1013	118	118	193	470	204	632	1125	118	118	193	482

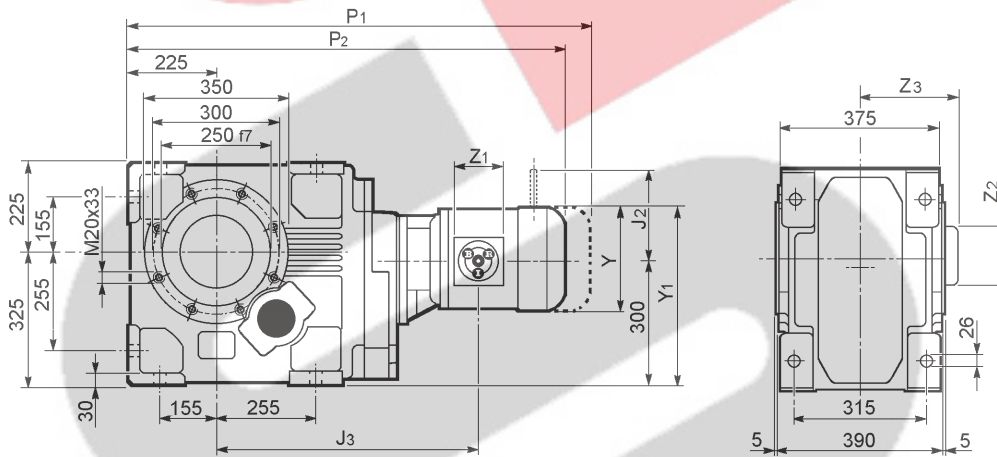

UR-UD UH-US	A 904														
	Tutti / All Alle / Tous		Motore / Motor / Motoren / Moteur M_						Motore / Motor / Motoren / Moteur M_FD						
	Y	Y ₁	J ₃	P ₂	Z ₁	Z ₂	Z ₃		J ₂	J ₃	P ₁	Z ₁	Z ₂	Z ₃	
A 904_S2 M2SA	156	378	590	968	85	85	124	435	129	630	1040	146	102	133	438
A 904_S2 M2SB	156	378	590	968	85	85	124	436	129	630	1040	146	102	133	439
A 904_S3 M3SA	195	398	613	1013	98	98	135	443	160	682	1108	165	110	155	448
A 904_S3 M3LA	195	398	613	1044	98	98	135	445	160	682	1139	165	110	155	450
A 904_S3 M3LB	195	398	613	1044	98	98	135	449	160	682	1139	165	110	155	454
A 904_S3 M3LC	195	398	613	1044	98	98	135	452	160	682	1139	165	110	155	457
A 904_S4 M4SA	258	429	631	1112	118	118	193	463	204	714	1224	118	118	193	473
A 904_S4 M4SB	258	429	631	1112	118	118	193	469	204	714	1224	118	118	193	479
A 904_S4 M4LA	258	429	631	1150	118	118	193	470	204	714	1262	118	118	193	480
A 904_S4 M4LB	258	429	631	1150	118	118	193	478	204	714	1262	118	118	193	490

A 90...UR

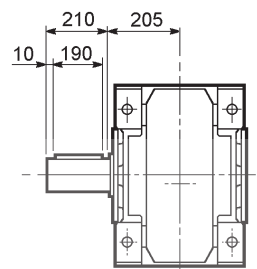
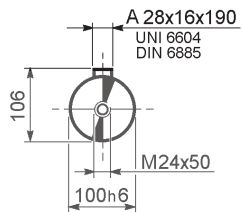

A 90...UD

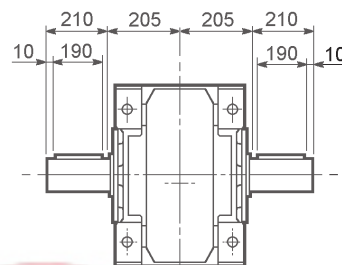
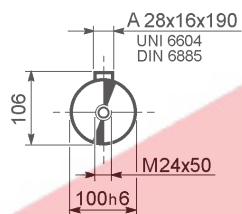

A 90...UH

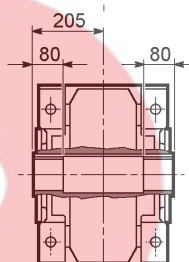
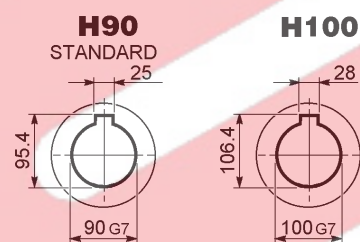

A 90...US

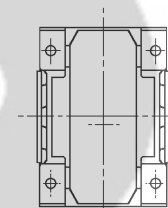
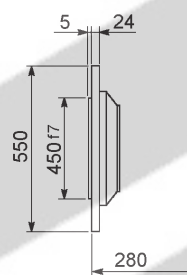
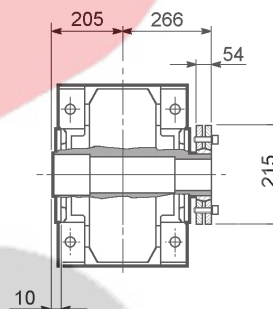
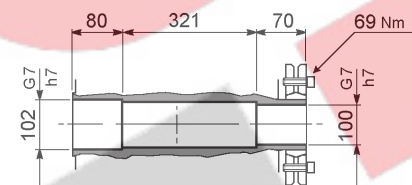

A 90...F...

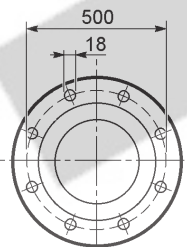

A