

Dimensioni Prodotto

Datasheet ID: testID

Creato da: technical@ricoth.it

Creato il: 03/06/2024

Designazione

W 110 U 40 P100 B5 V5 BX 100LA 4 230/400-50 IP55 CLF B5 U1

Dimensioni [mm], Italiceo [in]

Dimensioni Riduttore

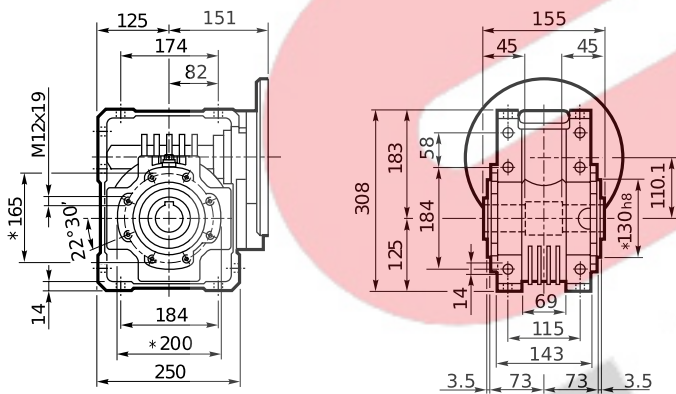

Dimensioni Ingresso

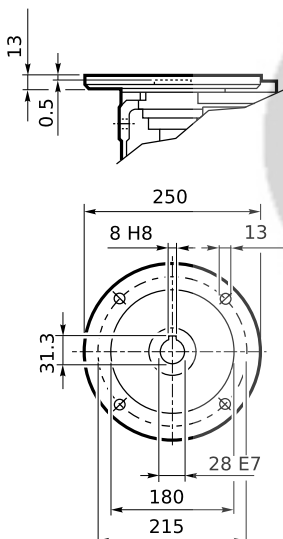

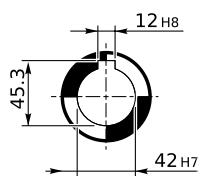
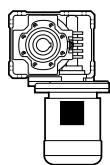
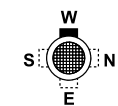
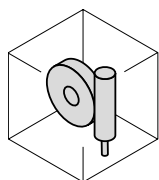
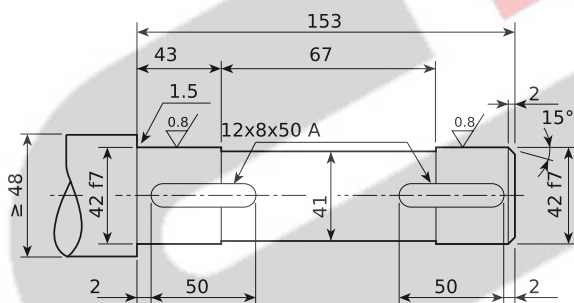
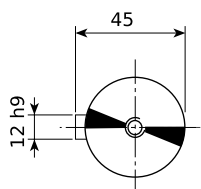
Albero Lento

Posizione di Montaggio

Albero Macchina

Dimensioni Motore

